



# *Split Controller*











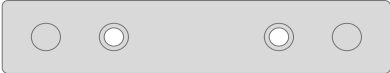

*SM-SS-F*

*User Manual*

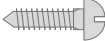
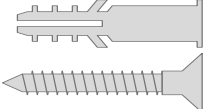
# Table of contents

<b>1. Parts illustration</b> .....	1
<b>2. Electrical technical data</b> .....	2
<b>3. Electrical connection</b> .....	3
<b>4. Assemble parts</b> .....	4
4.1 Assemble the fixed clamp.....	4
4.2 Assemble the fixed clasp.....	5
<b>5. Panel illustration</b> .....	6
5.1 Controller.....	6
5.2 Screen.....	7
5.2.1 Normal screen.....	7
5.2.2 Menu screen.....	7
<b>6. Function</b> .....	8
6.1 Temp Query.....	8
6.1.1 Menu schematic diagram.....	8
6.1.2 Illustration of menu.....	8
6.2 System Set.....	9
6.2.1 Menu schematic diagram.....	9
6.2.2 Illustration of menu.....	9
6.3 TD Set.....	10
6.3.1 Menu schematic diagram.....	10
6.3.2 Illustration of menu.....	10
6.4 HWP Set.....	11
6.4.1 Menu schematic diagram.....	11
6.4.2 Illustration of menu.....	11
6.5 Heating Set.....	12
6.5.1 Menu schematic diagram.....	12
6.5.2 Illustration of menu.....	12
6.6 HT Set.....	13
6.6.1 Menu schematic diagram.....	13
6.6.2 Illustration of menu.....	13
6.7 AF Set.....	14
6.7.1 Menu schematic diagram.....	14
6.7.2 Illustration of menu.....	14
6.8 Ste Set.....	15
6.8.1 Menu schematic diagram.....	15
6.8.2 Illustration of menu.....	15
6.9 Function icon.....	16
<b>7. Operation (An example)</b> .....	17
7.1 How to choose auto mode of heating function.....	17
7.2 How to set parameters of auto mode.....	18
7.3 How to change the important parameters.....	19
7.4 Convenient usage of “  ” button.....	20
7.5 Convenient usage of “  ” button.....	20

# 1. Parts illustration

Name	Figure	Illustration
Controller host		For Controller
Controller packing list		For Controller
Fixed clamp		For power cord
		For sensor signal line
Fixed clasp		For controller
Power cord		For solar pump
Screw		For fixed clamp
		For fixed clasp
Sensor		For T1
		For T2
		For T3
		For T4
User manual		For controller

## 2. Electrical technical data

NO.	Name	Specification
1	Size of controller	120mm×165mm×45mm
2	Ambient temperature of controller	-20℃～50℃
3	Protection type of controller	IP40
4	1 PT 1000 sensors of collector	-20℃～200℃ (±1℃) (PVC cable)
5	2 NTC 5K sensor of tank	-20℃～120℃ (±1℃) (PVC cable)
6	1 NTC 5K sensor of hot water pipe	-20℃～120℃ (±1℃) (PVC cable)
4	Power supply of controller	AC110V±10% 60Hz
		AC220V±10% 50Hz
8	Power consumption of controller	≤2W (AC110V±10% 60Hz)
		≤2W (AC220V±10% 50Hz)
9	Power supply of solar pump	AC110V±10% 60Hz
		AC220V±10% 50Hz
10	Power consumption of solar pump	≤250W (AC110V±10% 60Hz)
		≤250W (AC220V±10% 50Hz)
11	Power supply of circulating pump	AC110V±10% 60Hz
		AC220V±10% 50Hz
12	Power consumption of circulating pump	≤250W (AC110V±10% 60Hz)
		≤250W (AC220V±10% 50Hz)
13	Power supply of electric heating device	AC110V±10% 60Hz
		AC220V±10% 50Hz
14	Power consumption of electric heating device	≤2000W (AC110V±10% 60Hz)
		≤3000W (AC220V±10% 50Hz)

### 3. Electrical connection

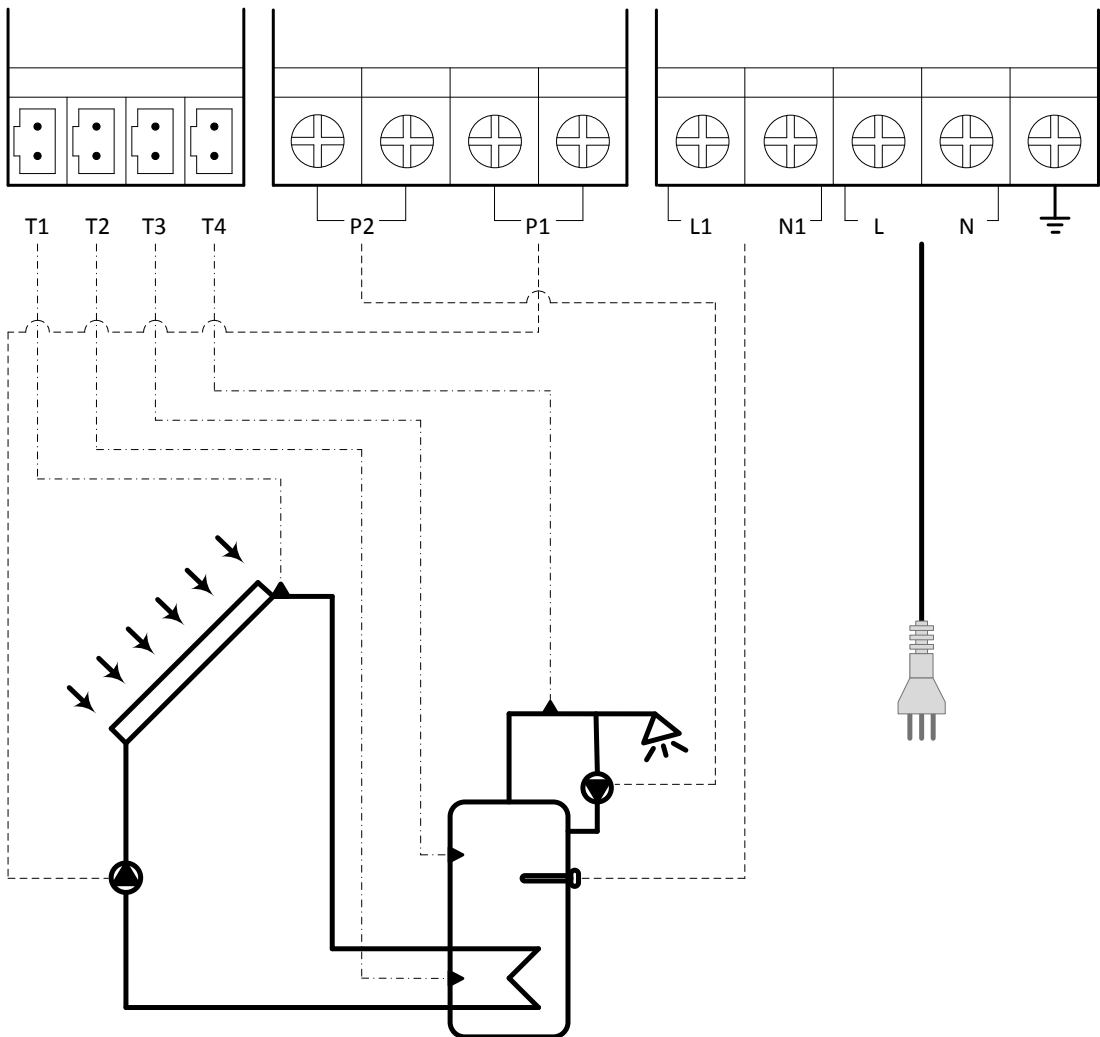

Symbol	Specification	Symbol	Specification
T1	Collector sensor	L1	Electric heating device
T2	Tank lower sensor	N1	
T3	Tank top sensor	L	Power supply
T4	Hot water pipe sensor	N	
P1	Solar pump	⏏	Earthing
P2	Circulating pump		

# 4. Assemble parts

## 4.1 Assemble the fixed clamp

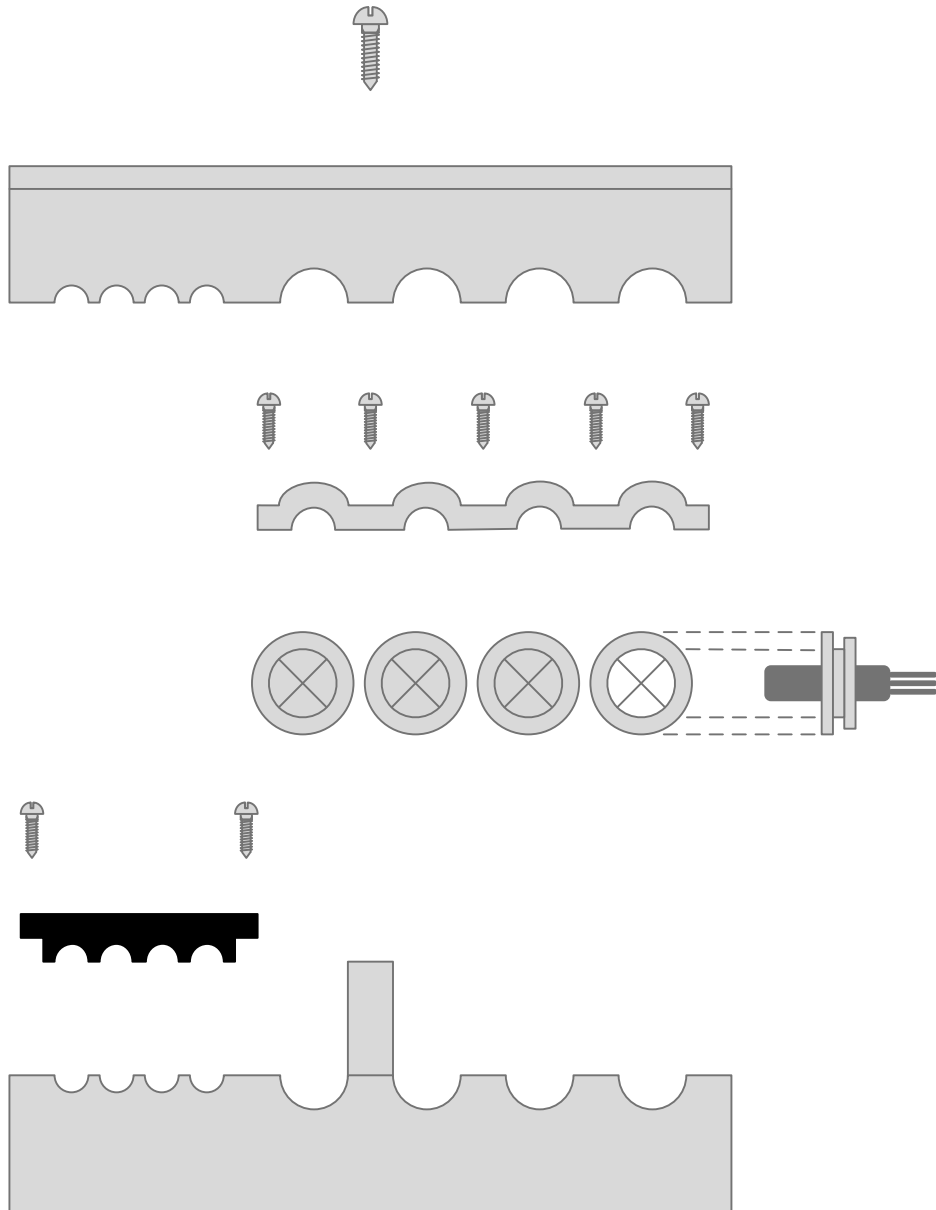



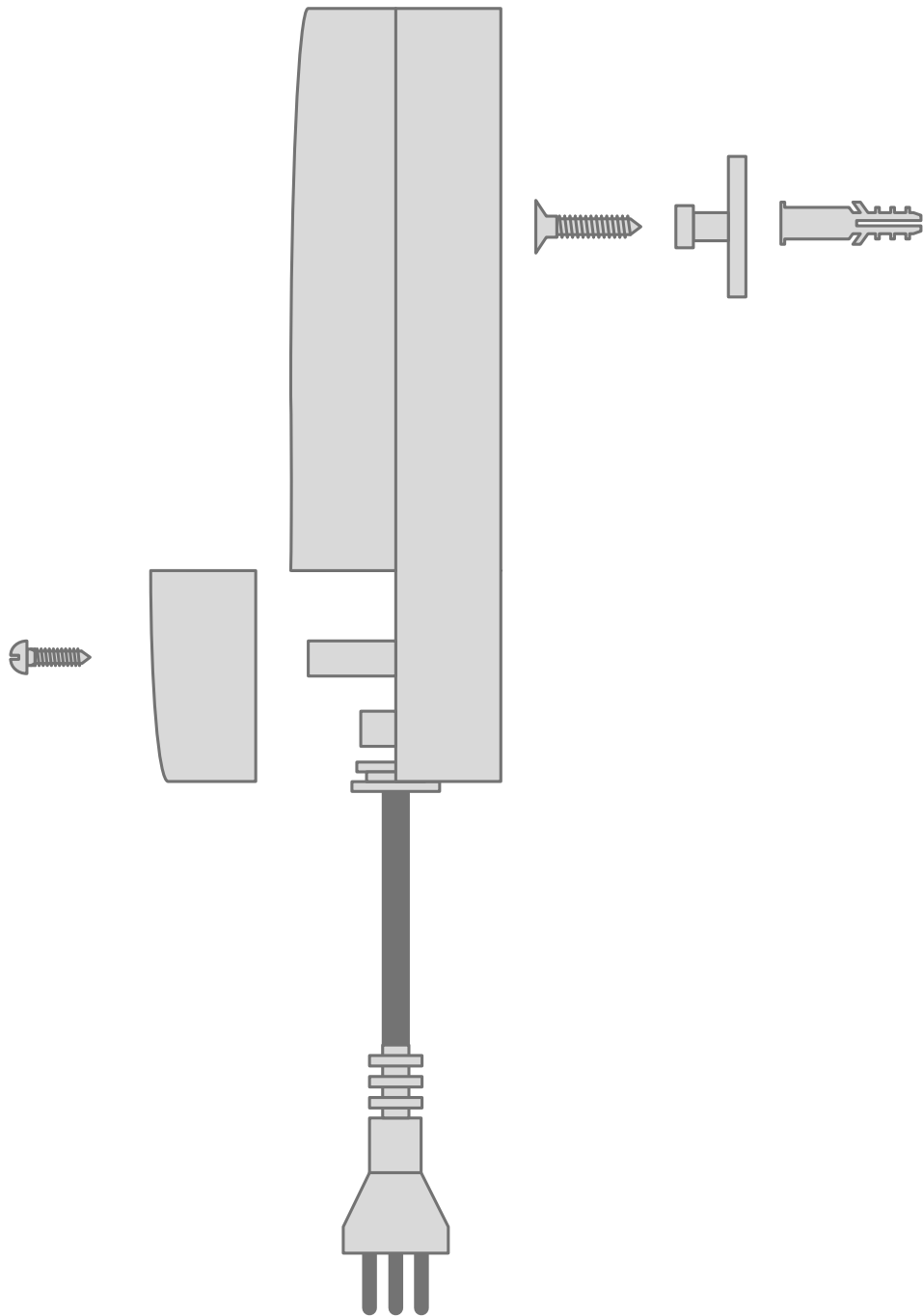

## 4.2 Assemble the fixed clasp

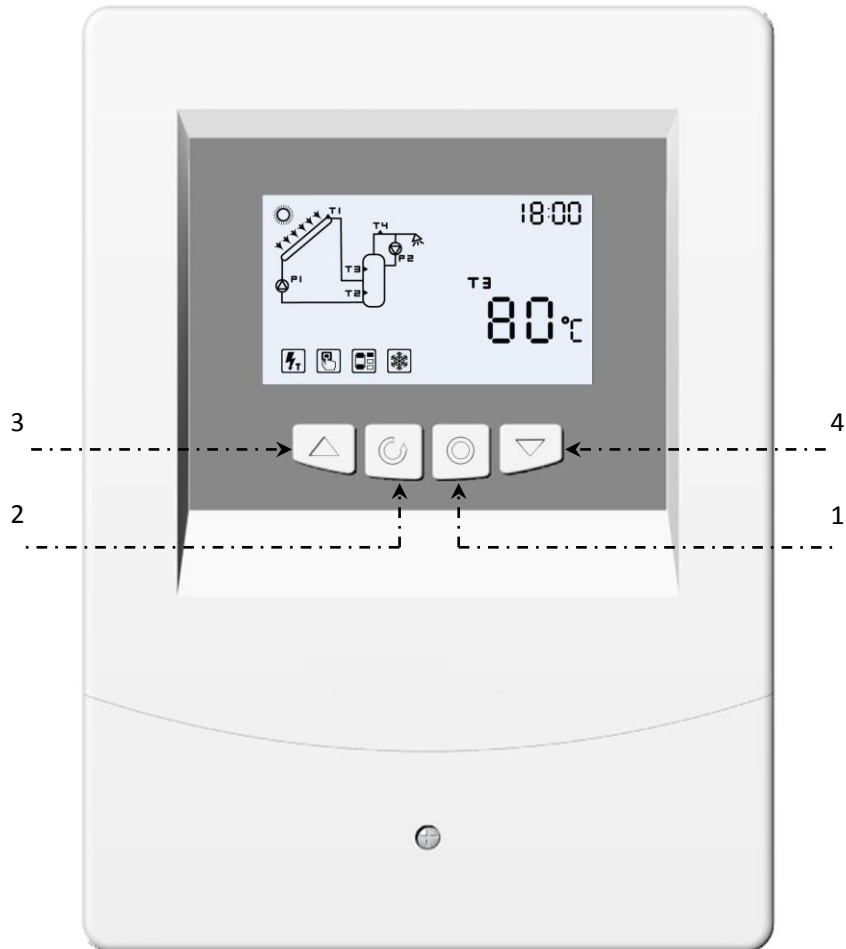

# 5. Panel illustration

## 5.1 Controller



NO.	Button	Normal Screen	Menu Screen
1		Into the menu screen	Confirmation
2		Into the menu screen	Return
3		Into the <i>heating set</i>	Move up cursor Increase parameter value
4		Into the <i>system set</i>	Move down cursor Decrease parameter value



## 5.2 Screen

### 5.2.1 Normal screen

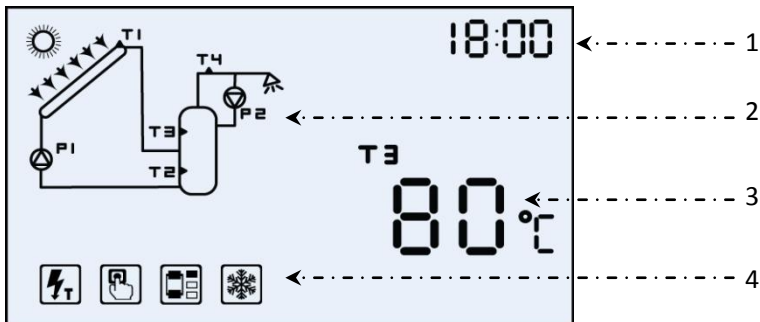

NO.	Illustration
1	Time
2	System schematic diagram
3	Designated sensor temperature
4	Function icon

### 5.2.2 Menu screen

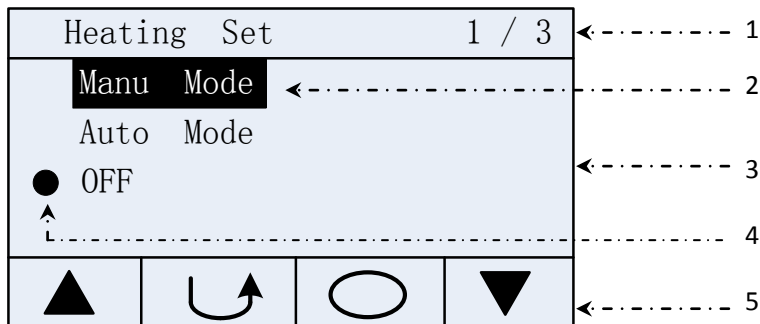

NO.	Illustration
1	Main menu
2	Cursor
3	Sub menu
4	Selected function icon
5	Allowed operation icon

# 6. Function

## 6.1 Temp Query

### 6.1.1 Menu schematic diagram

Temp Query	<p>T1: 100°C Good</p> <p>T2: 80°C Good</p> <p>● T3: ---°C Short</p> <p>T4: ---°C Open</p>
------------	---

### 6.1.2 Illustration of menu

Menu	Description
Temp Query	Query the temperature and working state of sensors
T1	Collector sensor temperature
T2	Tank lower sensor temperature
T3	Tank top sensor temperature (Factory setting: T3)
T4	Pipe sensor temperature
Good	Sensor normal operation
Short	Sensor Short circuit
Open	Sensor open circuit
●	Designated the sensor temperature will be shown in the normal screen

◆ When the *sensor failure* occurs,  will be shown in the normal screen and flicker.

## 6.2 System Set

### 6.2.1 Menu schematic diagram

System Set	Language/语言	中文 English
	Time Set	00:00
	Brn Set	5
	Set Restore	
	SN	080010001

### 6.2.2 Illustration of menu

Menu	Description
System Set	Set the basic parameters of system
Language/语言	Choose English or Chinese (Factory setting: English)
Time Set	Set the time
Brn Set	Set the brightness contrast Range: 0~9 (Factory setting: 5)
Set Restore	All parameters returned to the factory setting
SN	Query the serial number

## 6.3 TD Set

### 6.3.1 Menu schematic diagram

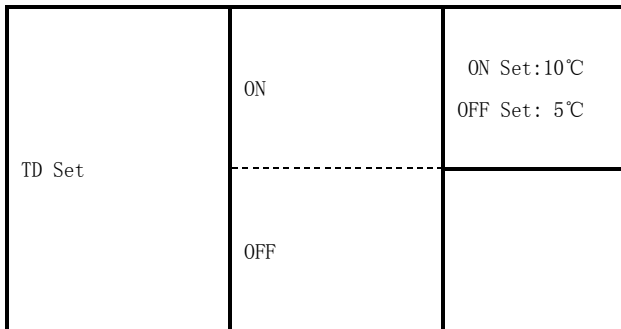

### 6.3.2 Illustration of menu

Menu	Description
TD Set	Temperature difference circulation
ON	On temperature difference circulation function (Factory setting: ON)
OFF	Off temperature difference circulation function
ON Set	Set the temperature difference for start solar pump (P1) Range: 6°C ~ 20°C (Factory setting: 10°C)
OFF Set	Set the temperature difference for stop solar pump (P1) Range: 2°C ~ 10°C (Factory setting: 5°C)

◆ When the temperature difference circulation function is **ON**,  will be shown in the normal screen.

And when the **solar pump** is operated,  will flicker.

## 6.4 HWP Set

### 6.4.1 Menu schematic diagram

HWP Set	Temp Mode	Temp Set	Tank Top :40℃ Pipe Upper:38℃ Pipe Lower:30℃
		Time Set	1、04:00-05:00
			2、OFF 3、17:00-22:00
	Time Mode	Temp Set	Tank Top :40℃
		Time Set	1、04:00-05:00
			2、OFF 3、17:00-22:00
OFF*			

### 6.4.2 Illustration of menu

Menu	Description
HWP Set	Hot water pipe circulation
Temp Mode	Temperature control mode
Time Mode	Time control mode
OFF*	OFF hot water pipe circulation function (Factory setting: OFF)
Temp Set	Set the temperature for start or Stop circulating pump (P2)
Time Set	Set the time period for start or Stop circulating pump (P2)
Tank Top	Tank top sensor temperature Range: 20℃~60℃ (Factory setting: 40℃)
Pipe Upper	Pipe upper limit temperature Range: 20℃~45℃ (Factory setting: 38℃)
Pipe Lower	Pipe lower limit temperature Range: 20℃~45℃ (Factory setting: 30℃)
1、04:00 – 05:00 2、OFF 3、17:00 – 22:00	Three time period of user defined. The time period will be <b>OFF</b> , if they are the same. (e.g. "08:00 – 08:00")

◆When the **Temp Mode** is chosen,  will be shown in the normal screen.

And when the **circulating pump** is operated,  will flicker.

◆When the **Time Mode** is chosen,  will be shown in the normal screen.

And when the **circulating pump** is operated,  will flicker.

## 6.5 Heating Set

### 6.5.1 Menu schematic diagram

Heating Set	Manu Mode	Temp Set	OFF Temp:60℃		
	Auto Mode	Temp Set	ON Temp:40℃ OFF Temp:60℃		
		Time Set	24H ON		
			24H OFF		
OFF*		User:		1、04:00-05:00 2、OFF 3、17:00-23:00	

### 6.5.2 Illustration of menu

Menu	Description
Heating Set	Electric heating
Manu Mode	Manual control mode
Auto Mode	Automatic control mode
OFF*	OFF electric heating function (Factory setting: OFF)
Temp Set	Set the temperature for start or Stop electric heating device
Time Set	Set the time period for start or Stop electric heating device
ON Temp	Set the temperature for start electric heating device Range: 0℃~50℃ (Factory setting: 40℃)
OFF Temp	Set the temperature for Stop electric heating device Range: 45℃~90℃ (Factory setting: 60℃)
24H ON	All day on electric heating function
24H OFF	All day off electric heating function
User	User defined the time period for start or Stop electric heating device
1、04:00 - 05:00 2、OFF 3、17:00 - 23:00	Three time period of user defined. The time period will be <b>OFF</b> , If they are the same. (e.g. "08:00 – 08:00")

◆ When the **Manu Mode** is chosen,  will be shown in the normal screen.

And when the **electric heating device** is operated,  will flicker.

◆ When the **Auto Mode** is chosen,  will be shown in the normal screen.

And when the **electric heating device** is operated,  will flicker.

## 6.6 HT Set

### 6.6.1 Menu schematic diagram

HT Set	ON	Tank Set	OFF Temp: 75°C
		Col Set	ON Temp: 115°C OFF Temp: 95°C
		Sys Set	OFF Temp: 140°C
	OFF		

### 6.6.2 Illustration of menu

Menu	Description
HT Set	High temperature protection
ON	ON high temperature protection function (Factory setting: ON)
OFF	OFF high temperature protection function
Tank Set	Tank protection
Col Set	Collector protection
Sys Set	System protection
ON Temp (Col Set)	Set the temperature for on collector protection Range: 100°C ~ 130°C (Factory setting: 115°C)
OFF Temp (Col Set)	Query the temperature for off collector protection Value : 95°C (Factory setting: 95°C)
OFF Temp (Tank Set)	Set the temperature for off tank protection Range: 50°C ~ 90°C (Factory setting: 75°C)
OFF Temp (Sys Set)	Query the temperature for off system protection Value : 140°C (Factory setting: 140°C)

◆ When the High temperature protection function is **ON**,  will be shown in the normal screen.

And when the **tank protection** is operated,  will be shown in the normal screen.

And when the **collector protection** is operated,  will be shown in the normal screen.

And when the **system protection** is operated,  will be shown in the normal screen.

## 6.7 AF Set

### 6.7.1 Menu schematic diagram

AF Set	ON	ON Set:10°C OFF Set:15°C
	OFF	

### 6.7.2 Illustration of menu

Menu	Description
AF Set	Anti-freeze protection
ON	On anti-freeze function
OFF	Off anti-freeze function (Factory setting: OFF)
ON Set	Set the temperature for open solar pump (P1) Range: -10°C ~ 30°C (Factory setting: 10°C)
OFF Set	Set the temperature for stop solar pump (P1) Range: -10°C ~ 30°C (Factory setting: 15°C)

◆ When the Anti-freeze function is **ON**,  will be shown in the normal screen.

And when the **solar pump** is operated,  will flicker.



## 6.8 Ste Set

### 6.8.1 Menu schematic diagram

Ste Set	ON	ON Time:23:00 OFF Temp:70°C
	OFF	

### 6.8.2 Illustration of menu













Menu	Description
Ste Set	Sterilization protection
ON	On sterilization protection function
OFF	Off sterilization protection function (Factory setting: OFF)
ON Time	Query the time for start electric heater Value : 23:00 – 04:00 (Factory setting: 23:00 – 04:00)
OFF Temp	Query the temperature for stop electric heater Value : 70°C (Factory setting: 70°C)

◆ When the Sterilization protection function is **ON**,  will be shown in the normal screen.

And when the **electric heating device** is operated,  will flicker.

◆ In the case of **ON** electric heating and **ON** sterilization protection function, when the water temperature in the tank is below 70°C for 7 days, the electric heating device will be operated at 23:00 of the 7<sup>th</sup> day, heating the water to 70°C, at which time the electric heating device will switch off. If the water temperature in the tank is still below 70°C at 4:00 of the 8<sup>th</sup> day, the electric heating device will switch off. If the **tank protection** temperature is set below 70°C, the electric heating device will only heat the water to the **tank protection** temperature, then switch off.

## 6.9 Function icon

Icon	Illustration
	Sensor failure
	Temperature difference circulation
	"Temp Mode" of hot water pipe circulation
	"Time Mode" of hot water pipe circulation
	"Manu Mode" of electric heating
	"Auto Mode" of electric heating
	High temperature protection
	"Tank Set" of high temperature protection
	"Col Set" of high temperature protection
	"Sys Set" of high temperature protection
	Anti-freeze protection
	Sterilization protection

# 7. Operation (An example)

Before carrying out the operation, press any button to illuminate the screen.

## 7.1 How to choose auto mode of heating function

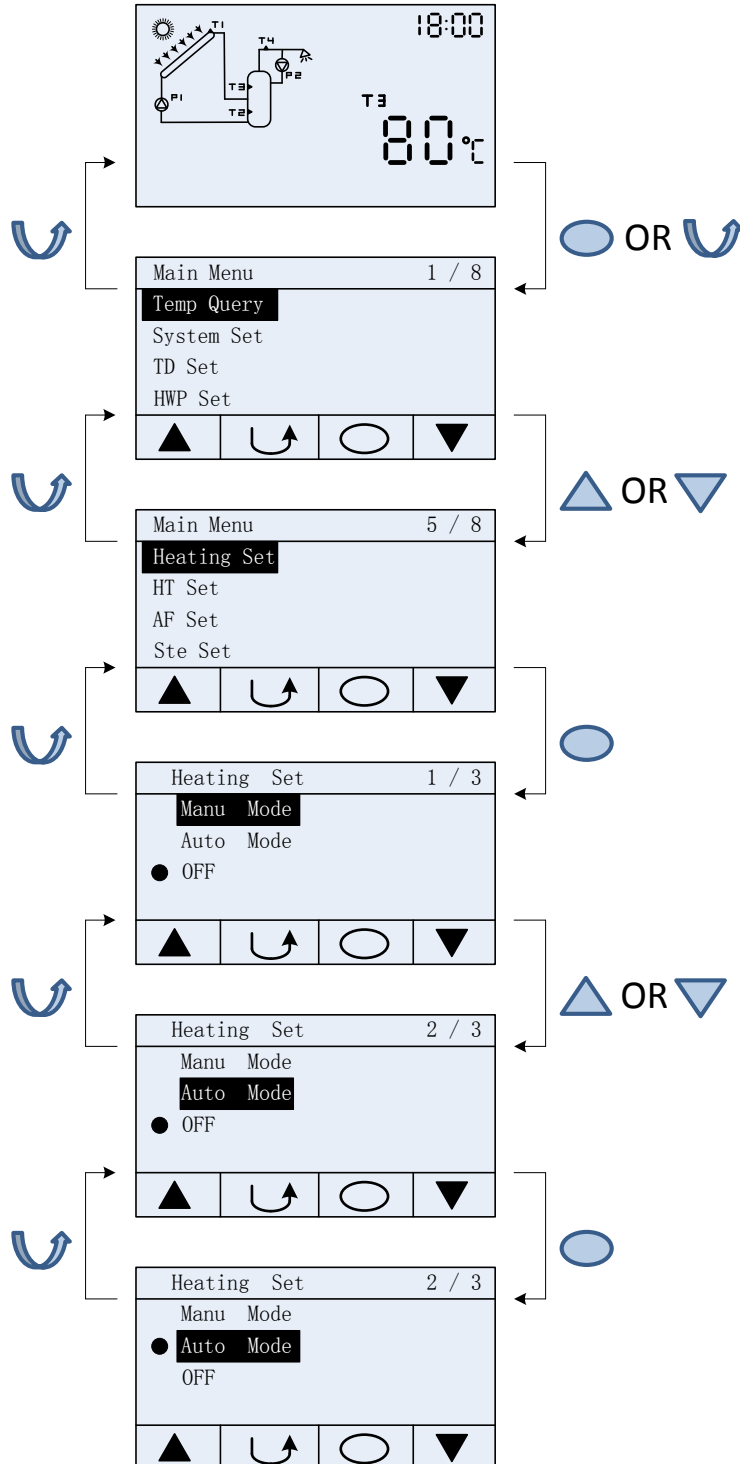

## 7.2 How to set parameters of auto mode

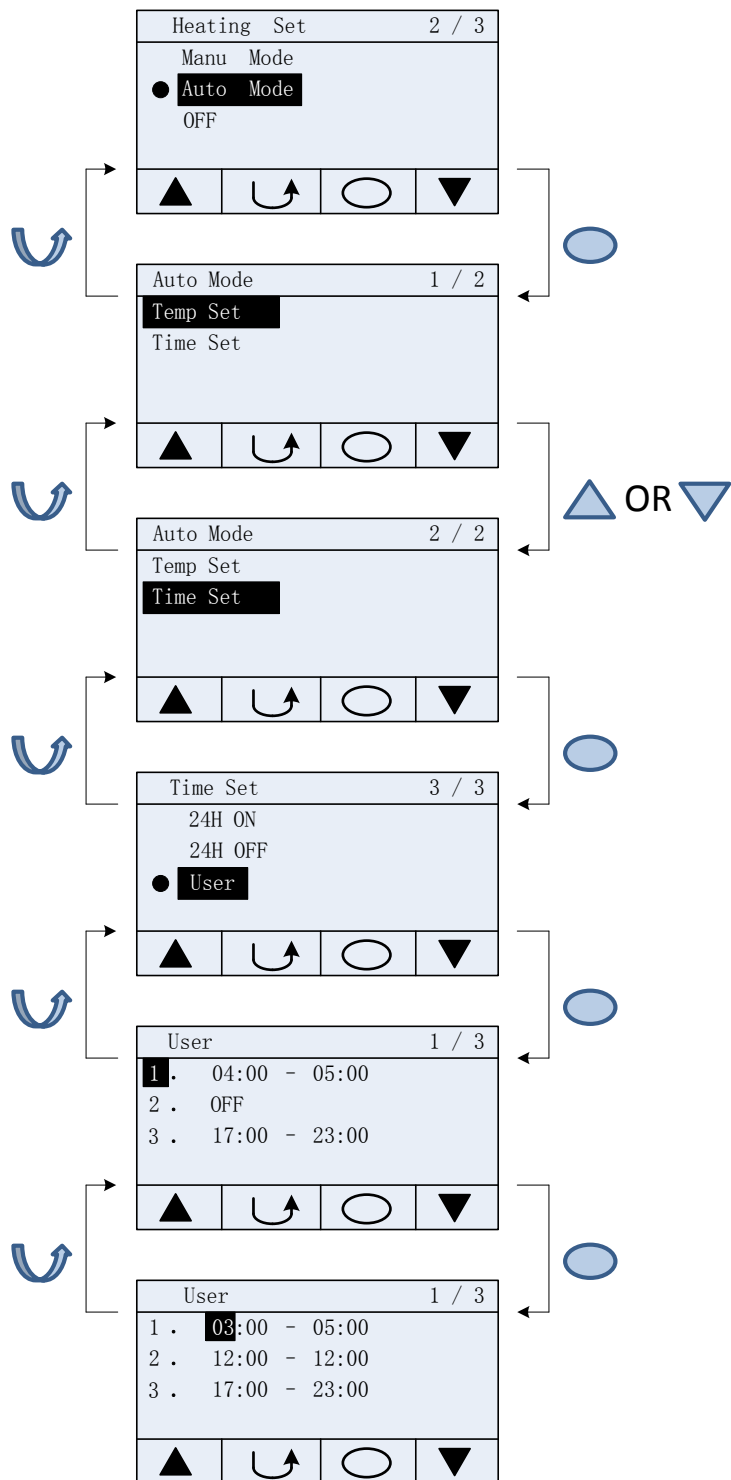

### 7.3 How to change the important parameters

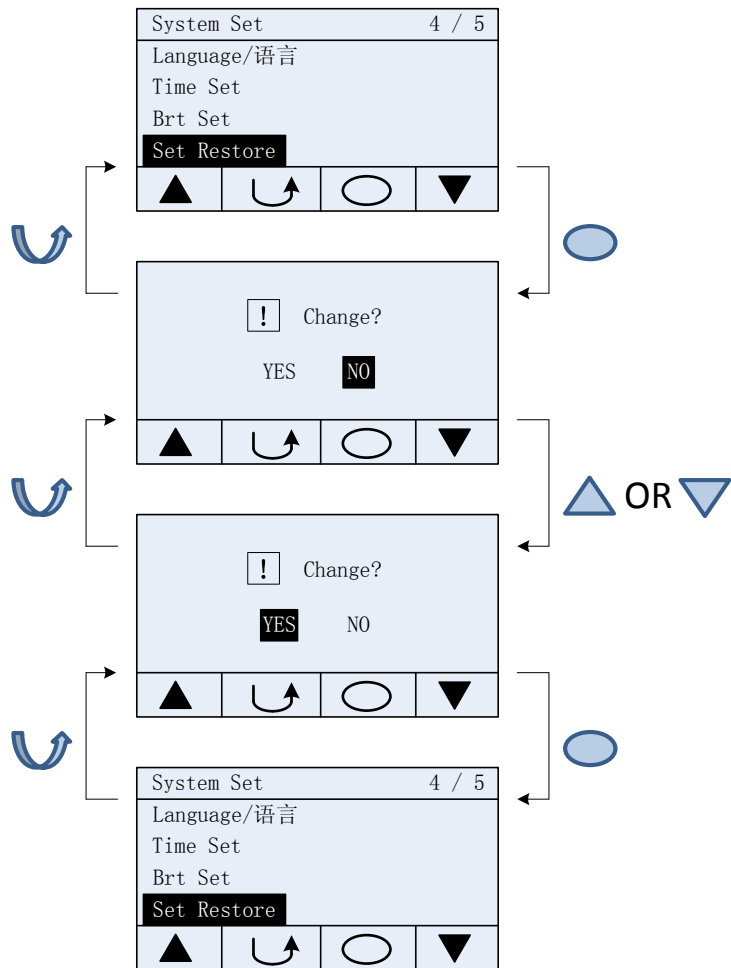

## 7.4 Convenient usage of “▲” button

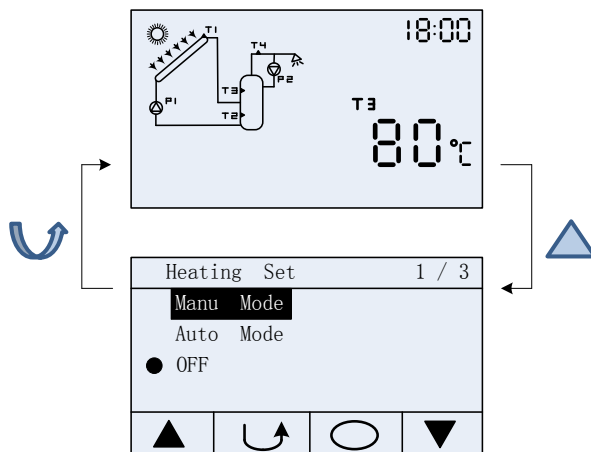

## 7.5 Convenient usage of “▼” button

